

Models  
KEYS977E  
KGYS977E

# USE & CARE GUIDE

**KitchenAid®**

## Electronic Dryers

A Note to You .....	2
Understanding Dryer Safety .....	3-4
Getting to Know Your Dryer .....	5
Checking Your Vent .....	6
Operating Your Dryer .....	8
Using Other Features ....	15
Caring for Your Dryer ....	19
Troubleshooting .....	24
Requesting Assistance or Service .....	26
Index .....	27
Warranty .....	28

**1•800•422•1230**

Call with questions  
or comments

# A NOTE TO YOU

## Thank you for buying a KITCHENAID® appliance!

KitchenAid designs the best tools for the most important room in your house. To ensure that you enjoy many years of trouble-free operation, we developed this Use and Care Guide. It contains valuable information concerning how to operate and maintain your new appliance properly and safely. Please read it carefully.

Also, please complete and mail the enclosed Product Registration Card.

## For assistance or service

Call the Consumer Assistance Center toll free ..... **1-800-422-1230**

If you need assistance or service, first see the "Troubleshooting" section of this book. After checking "Troubleshooting," additional help can be found by checking the "Requesting Assistance or Service" section, or by calling the telephone number above.

When calling, you will need to know your appliance's complete model number and serial number. You can find this information on the model and serial number label (see diagram on page 5).

Keep this book and the sales slip together in a safe place for future reference. **You must provide proof of purchase or installation date for in-warranty service.**

<b>Model Number</b> _____	<b>Builder/Dealer Name</b> _____
<b>Serial Number</b> _____	<b>Address</b> _____
<b>Date Installed</b> _____	<b>Phone</b> _____

# UNDERSTANDING DRYER SAFETY

## **Your safety is important to us.**

This guide contains safety symbols and statements. Please pay special attention to these symbols and follow any instructions given. Here is a brief explanation of the use of the symbol.



This symbol alerts you to hazards such as fire, electrical shock, or other injuries.

**WARNING: For your safety, the information in this manual must be followed to minimize the risk of fire or explosion, or to prevent property damage, personal injury, or loss of life.**

- **Do not store or use gasoline or other flammable vapors and liquids in the vicinity of this or any other appliance.**
- **WHAT TO DO IF YOU SMELL GAS:**
  - **Do not try to light any appliance.**
  - **Do not touch any electrical switch; do not use any phone in your building.**
  - **Clear the room, building, or area of all occupants.**
  - **Immediately call your gas supplier from a neighbor's phone. Follow the gas supplier's instructions.**
  - **If you cannot reach your gas supplier, call the fire department.**
- **Installation and service must be performed by a qualified installer, service agency, or the gas supplier.**

continued on next page

# UNDERSTANDING DRYER SAFETY

## IMPORTANT SAFETY INSTRUCTIONS

**WARNING** – To reduce the risk of fire, electric shock, or injury to persons when using the dryer, follow basic precautions, including the following:

- Read all instructions before using the dryer.
- Do not dry articles that have been previously cleaned in, washed in, soaked in, or spotted with gasoline, dry-cleaning solvents, other flammable, or explosive substances as they give off vapors that could ignite or explode.
- Do not allow children to play on or in the dryer. Close supervision of children is necessary when the dryer is used near children.
- Before the dryer is removed from service or discarded, remove the door to the drying compartment.
- Do not reach into the dryer if the drum is moving.
- Do not install or store the dryer where it will be exposed to the weather.
- Do not tamper with controls.
- Do not repair or replace any part of the dryer or attempt any servicing unless specifically recommended in this Use and Care Guide or in published user-repair instructions that you understand and have the skills to carry out.
- Do not use fabric softeners or products to eliminate static unless recommended by the manufacturer of the fabric softener or product.
- Do not use heat to dry articles containing foam rubber or similarly textured rubber-like materials.
- Clean lint screen before or after each load.
- Keep area around the exhaust opening and adjacent surrounding areas free from the accumulation of lint, dust, and dirt.
- The interior of the dryer and exhaust vent should be cleaned periodically by qualified service personnel.
- See Installation Instructions for grounding requirements.

– SAVE THESE INSTRUCTIONS –

# GETTING TO KNOW YOUR DRYER

The parts and features of your dryer are illustrated on this page. Become familiar with all parts and features before using your dryer. Page references are included next to some features. Refer to those pages for more information about the features.

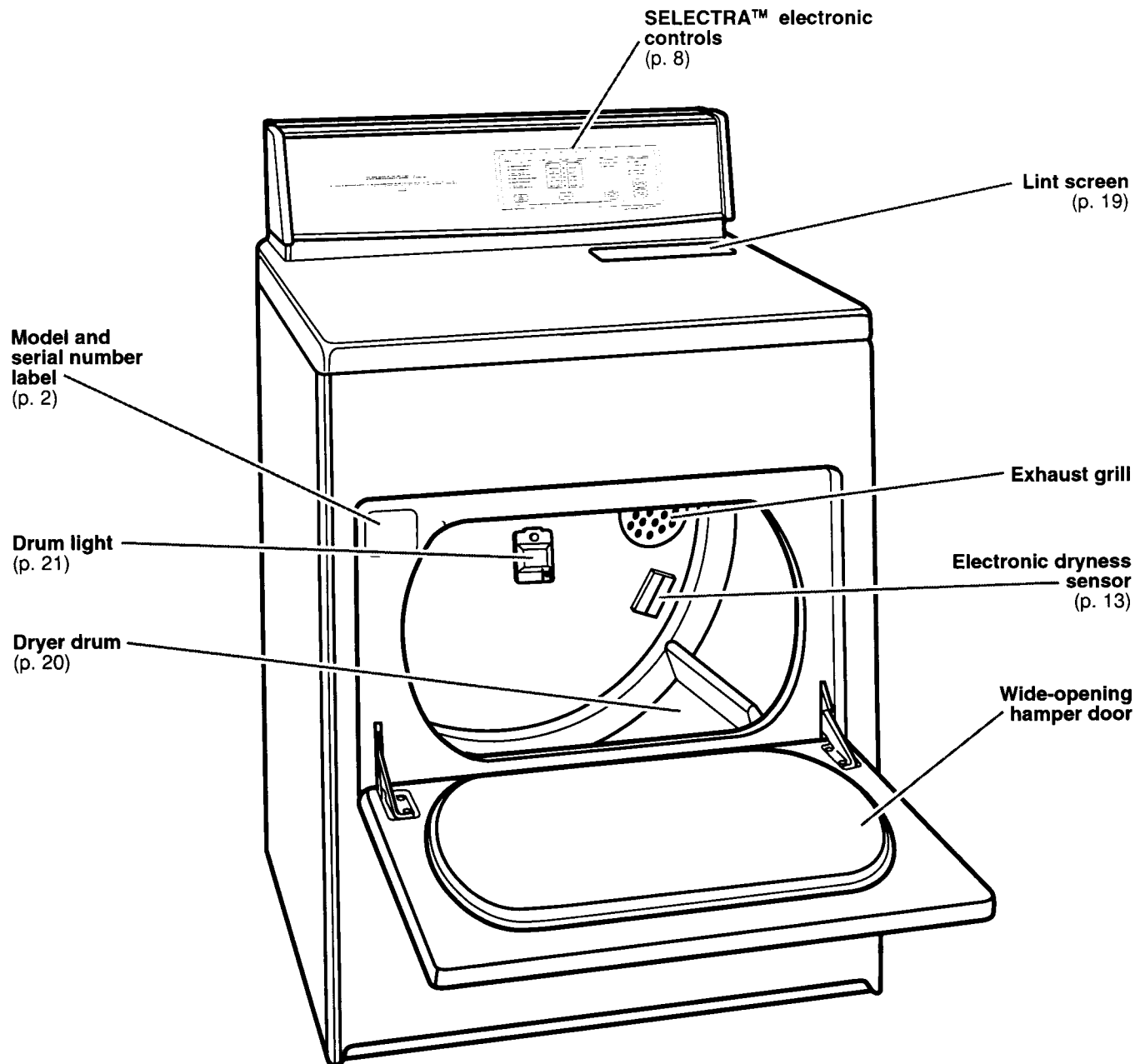

## **Additional feature your dryer has:**

**ULTRA LOW temperature setting**  
(p. 11)

# CHECKING YOUR VENT

Your dryer must be properly installed and vented to achieve maximum drying efficiency. Install your dryer in a well-ventilated room where the temperature is always above 45°F (7°C). Also make sure that your dryer is leveled. Refer to your Installation Instructions for more information.

## Venting

### ⚠ WARNING



#### Fire Hazard

Use a heavy metal vent.

Do not use a plastic vent.

Do not use a metal foil vent.

Failure to follow these instructions can result in death or fire.

If the dryer is not properly installed and vented, it will not be covered under the warranty.

**NOTE:** Service calls caused by improper venting will be paid for by the customer, whether it was a paid installation or self-installed. For paid installation, call the company that installed the vent for adjustment.

1. Four-inch heavy metal or flexible metal vent must be used. **Do not** use plastic vent or flexible metal foil vent. Do not kink or crush flexible metal vent. It must be completely extended to allow adequate exhaust air to flow. Check vent after installation. Refer to your Installation Instructions for proper

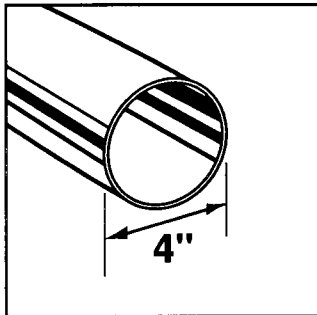

length requirements of vent.

2. Use a 4" exhaust hood. Smaller hoods increase drying times.

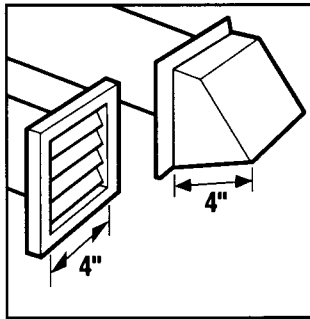

3. The exhaust vent can be routed up, down, left, right, or straight out the back of the dryer. Space requirements are listed in your Installation Instructions.

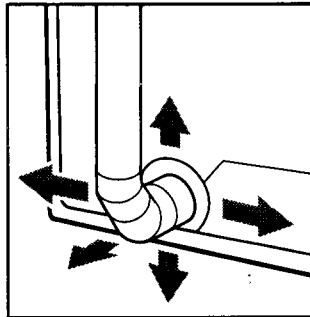

# CHECKING YOUR VENT

## Venting (cont.)

4. Use the straightest path possible when routing the exhaust vent. Avoid 90° turns, if possible. Allow room when using elbows or making turns. Bend vent gradually to avoid kinking.

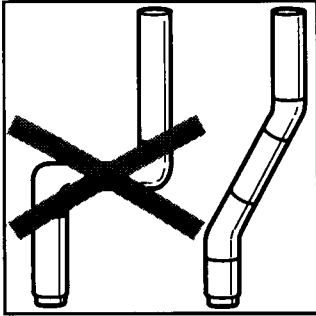

5. Use duct tape to seal all joints. **Do not** use screws to secure vent. Lint may catch on screws.

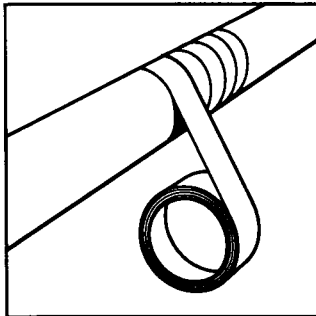

6. Clean exhaust vent periodically, depending on use, but at least every 2 years, or when installing your dryer in a new location.

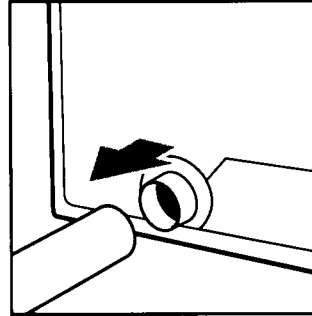

- Disconnect vent from the dryer and clean one section at a time until you reach the exhaust hood.

- Use the hose attachment on your vacuum, or a pole or wire with

a feather duster or rag attached, to clean out lint.

- Be sure the flapper on the outside end of vent moves freely.
- When cleaning is complete, be sure to follow the Installation Instructions supplied with your dryer for final product check.

# OPERATING YOUR DRYER

To get the best dryer results possible, you must use your dryer correctly. This section tells you how to use your dryer properly and efficiently.

## Understanding the SELECTRA™ electronic controls

Your new electronic dryer has solid state SELECTRA controls, as illustrated below. Many of the electronic features and options may be new to you. They are described on the following pages.

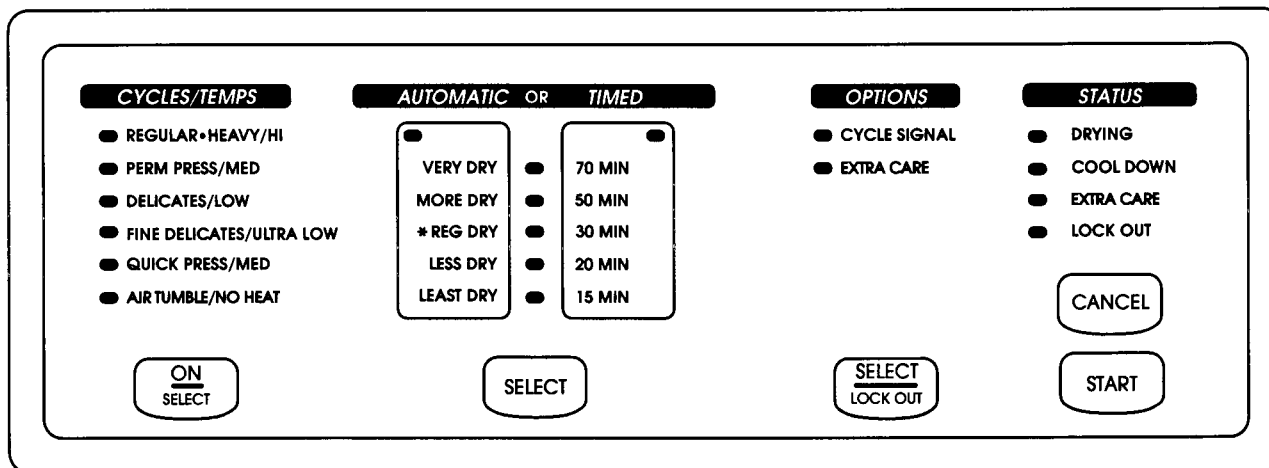

Audible tones guide your selections. You hear:

- one tone if the dryer accepts your selection.
- three tones if the dryer does not accept your selection.

## Before starting your dryer

### ⚠ WARNING



#### Explosion Hazard

**Never place items in the dryer that are dampened with gasoline or other flammable fluids.**

**No washer can completely remove oil.**

**Do not dry anything that has ever had any type of oil on it (including cooking oils).**

**Doing so can result in death, explosion, or fire.**

- Wipe the dryer drum with a damp cloth before using to remove dust from storing and shipping.
- If your dryer has a Consumer Buy Guide, remove it and place it with your Use and Care Guide.
- Load clothes loosely into the dryer and close the door. Do not pack the dryer; allow space for clothes to tumble freely.





# OPERATING YOUR DRYER

## Starting your dryer

### Preset selections

As shown in the illustration, the preset selections are Regular•Heavy/Hi, Automatic, (\*) Reg Dry, with Cycle Signal and Extra Care options On. This section tells you how to change any of those selections.

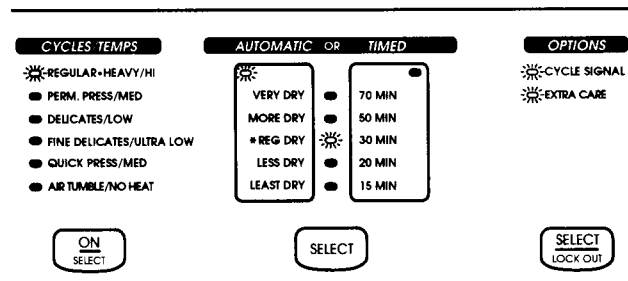

Preset Selections

### Choosing other selections:

If you do not want to use the preset settings, you can make other selections as follows:

1. Press **On/Select** until the light glows by the cycle/temp you prefer. See the chart on pages 10-12 to help guide your selections.

2. Press **Select** below any setting you wish to change (Automatic or Timed, or Options). Continue to press **Select** until the light glows by the setting you prefer.

3. Press **Start**. The “Drying” Status light will glow.

**NOTE:** Pressing **Start** will save all options that have been selected within the cycle you choose. These customized options will be displayed each time the cycle is selected, but can be changed if you prefer. See “Understanding the Custom Memory feature” on page 17.

PRESS



YOU SEE

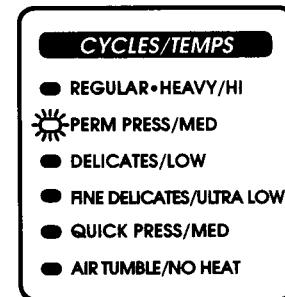

PRESS



PRESS



## Stopping/restarting your dryer

1. To stop your dryer at any time (to add or remove clothes):

- Open the dryer door. The “Drying” Status light will blink while the door is open.

**OR**

- Press **Cancel**. **Cancel** will clear current settings and any remaining cycle times.

2. To restart the dryer, close the dryer door and repeat Steps 1 through 3 in the “Starting your dryer” section.

PRESS



# OPERATING YOUR DRYER

## Selecting the right cycle and temperature setting





The following pages describe the drying cycles on your dryer. The descriptions include suggested temperature settings and drying times for various loads.

### Cycle and temperature tips

- Your dryer has a special Ultra Low temperature setting that reduces drying temperatures, providing enhanced fabric care for delicates and other fine fabrics.
- In the Automatic cycles, the FLO-THRU™ Drying System automatically reduces the heat near the end of the cycles to prevent overdrying.
- The last few minutes of all cycles are without heat to make the load cooler to handle.











### Drying tips

- Make sure you have selected the correct cycle and temperature for your load.
- Always follow care label directions when they are available.
- Always use fabric softener sheets labeled as dryer safe and follow package instructions carefully.
- Remove the load from the dryer as soon as tumbling stops to reduce wrinkling. This is especially important for permanent press, knits, and synthetic fabrics.

CYCLE/TEMP	USE FOR	CYCLE NOTES
<p><b>Regular•Heavy/Hi</b></p> <div style="border: 1px solid black; padding: 5px; margin-bottom: 10px;"> <p style="text-align: center; background-color: black; color: white; margin: 0;"><b>CYCLES/TEMPS</b></p> <ul style="list-style-type: none"> <li> REGULAR•HEAVY/HI</li> <li><input type="radio"/> PERM PRESS/MED</li> <li><input type="radio"/> DELICATES/LOW</li> <li><input type="radio"/> FINE DELICATES/ULTRA LOW</li> <li><input type="radio"/> QUICK PRESS/MED</li> <li><input type="radio"/> AIR TUMBLE/NO HEAT</li> </ul> </div> <p><b>Preset Selections</b></p> <ul style="list-style-type: none"> <li> AUTOMATIC</li> <li> REG DRY</li> <li> CYCLE SIGNAL</li> <li> EXTRA CARE</li> </ul>	<p><b>Cotton and Linens</b></p> <ul style="list-style-type: none"> <li>• Extra Heavy or Heavyweight items; bedspreads, mattress pads, quilts, towels, jeans, corduroys, work clothes</li> <li>• Mediumweight items; sheets, cotton underwear, diapers</li> </ul>	<ul style="list-style-type: none"> <li>• You may select a different Automatic dryness or use a Timed setting.</li> <li>• Automatic drying will dry a load in less time than a Timed setting, and will be less likely to overdry.</li> <li>• See “Using Automatic drying” on page 13.</li> </ul>

# OPERATING YOUR DRYER

## Selecting the right cycle and temperature setting (cont.)

CYCLE/TEMP	USE FOR	CYCLE NOTES
<p><b>Perm Press/Med</b></p> <div style="border: 1px solid black; padding: 5px; margin-bottom: 10px;"> <p style="text-align: center;"><b>CYCLES/TEMPS</b></p> <ul style="list-style-type: none"> <li><input type="radio"/> REGULAR•HEAVY/HI</li> <li><input checked="" type="radio"/> PERM PRESS/MED</li> <li><input type="radio"/> DELICATES/LOW</li> <li><input type="radio"/> FINE DELICATES/ULTRA LOW</li> <li><input type="radio"/> QUICK PRESS/MED</li> <li><input type="radio"/> AIR TUMBLE/NO HEAT</li> </ul> </div> <p><b>Preset Selections</b></p> <ul style="list-style-type: none"> <li> AUTOMATIC</li> <li> REG DRY</li> <li> CYCLE SIGNAL</li> <li> EXTRA CARE</li> </ul>	<p><b>Cotton and Linens</b></p> <ul style="list-style-type: none"> <li>• Lightweight; batistes, organdies, lingerie</li> </ul> <p><b>Permanent Press, Synthetics, Blends</b></p> <ul style="list-style-type: none"> <li>• Heavy or Mediumweight; work clothes, jackets, raincoats, shirts, play clothes, sheets, slacks</li> </ul> <p><b>Knits</b></p> <ul style="list-style-type: none"> <li>• Heavy or Mediumweight; cottons, rayons, blends, T-shirts, slacks, shirts, synthetics (polyester, acrylic, etc.), dress slacks, skirts, sweaters</li> </ul>	<ul style="list-style-type: none"> <li>• Use the Extra Care option with this cycle to ensure the best wrinkle-free drying.</li> </ul>
<p><b>Delicates/Low</b></p> <div style="border: 1px solid black; padding: 5px; margin-bottom: 10px;"> <p style="text-align: center;"><b>CYCLES/TEMPS</b></p> <ul style="list-style-type: none"> <li><input type="radio"/> REGULAR•HEAVY/HI</li> <li><input type="radio"/> PERM PRESS/MED</li> <li><input checked="" type="radio"/> DELICATES/LOW</li> <li><input type="radio"/> FINE DELICATES/ULTRA LOW</li> <li><input type="radio"/> QUICK PRESS/MED</li> <li><input type="radio"/> AIR TUMBLE/NO HEAT</li> </ul> </div> <p><b>Preset Selections</b></p> <ul style="list-style-type: none"> <li> AUTOMATIC</li> <li> REG DRY</li> <li> CYCLE SIGNAL</li> <li> EXTRA CARE</li> </ul>	<p><b>Knits</b></p> <ul style="list-style-type: none"> <li>• Lightweight; synthetics (polyester, acrylic, etc.), blends, blouses, and dresses</li> </ul>	<ul style="list-style-type: none"> <li>• Use this setting to reduce heat on garments.</li> </ul>
<p><b>Fine Delicates/ Ultra Low</b></p> <div style="border: 1px solid black; padding: 5px; margin-bottom: 10px;"> <p style="text-align: center;"><b>CYCLES/TEMPS</b></p> <ul style="list-style-type: none"> <li><input type="radio"/> REGULAR•HEAVY/HI</li> <li><input type="radio"/> PERM PRESS/MED</li> <li><input type="radio"/> DELICATES/LOW</li> <li><input checked="" type="radio"/> FINE DELICATES/ULTRA LOW</li> <li><input type="radio"/> QUICK PRESS/MED</li> <li><input type="radio"/> AIR TUMBLE/NO HEAT</li> </ul> </div> <p><b>Preset Selections</b></p> <ul style="list-style-type: none"> <li> AUTOMATIC</li> <li> REG DRY</li> <li> CYCLE SIGNAL</li> </ul>	<p><b>Delicate Fabrics</b></p> <ul style="list-style-type: none"> <li>• Lingerie, exercise wear</li> <li>• Sheer curtains, gauze, lace, etc.</li> </ul>	<ul style="list-style-type: none"> <li>• This cycle setting reduces drying temperatures, providing better fabric care for delicates and other fine fabrics.</li> </ul>

continued on next page

# OPERATING YOUR DRYER

## Selecting the right cycle and temperature setting (cont.)

CYCLE/TEMP	USE FOR	CYCLE NOTES
<p><b>Quick Press/Med</b></p> <div style="border: 1px solid black; padding: 5px; margin-bottom: 10px;"> <p><b>CYCLES/TEMPS</b></p> <ul style="list-style-type: none"> <li>● REGULAR • HEAVY/HI</li> <li>● PERM PRESS/MED</li> <li>● DELICATES/LOW</li> <li>● FINE DELICATES/ULTRA LOW</li> <li>☀️ QUICK PRESS/MED</li> <li>● AIR TUMBLE/NO HEAT</li> </ul> </div> <p><b>Preset Selections</b></p> <ul style="list-style-type: none"> <li>☀️ TIMED</li> <li>☀️ 30 MIN</li> <li>☀️ CYCLE SIGNAL</li> <li>☀️ EXTRA CARE</li> </ul>	<ul style="list-style-type: none"> <li>• Removing wrinkles from clothes that have been packed in a suitcase</li> <li>• Removing wrinkles from items not removed from the dryer at the end of a cycle</li> </ul>	<ul style="list-style-type: none"> <li>• This cycle uses a fixed, 30-minute, Timed setting that cannot be changed.</li> <li>• As soon as the dryer stops, fold or put items on hanger.</li> </ul>

## ⚠️ WARNING



### Fire Hazard

Use Air Tumble/No Heat or line dry items listed below.

Do not use heat to dry these items.

Failure to follow these instructions can result in death or fire.

<p><b>Air Tumble/No Heat</b></p> <div style="border: 1px solid black; padding: 5px; margin-bottom: 10px;"> <p><b>CYCLES/TEMPS</b></p> <ul style="list-style-type: none"> <li>● REGULAR • HEAVY/HI</li> <li>● PERM PRESS/MED</li> <li>● DELICATES/LOW</li> <li>● FINE DELICATES/ULTRA LOW</li> <li>● QUICK PRESS/MED</li> <li>☀️ AIR TUMBLE/NO HEAT</li> </ul> </div> <p><b>Preset Selections</b></p> <ul style="list-style-type: none"> <li>☀️ TIMED</li> <li>☀️ 50 MIN</li> <li>☀️ CYCLE SIGNAL</li> <li>☀️ EXTRA CARE</li> </ul>	<p><b>Rubber, Plastic, Heat-Sensitive Fabrics</b></p> <ul style="list-style-type: none"> <li>• Foam Rubber – Pillows, padded bras, stuffed toys (20-30 minutes) <ul style="list-style-type: none"> <li>– Make sure coverings are securely stitched.</li> <li>– Shake and fluff pillows by hand several times during the Air Tumble/No Heat cycle.</li> <li>– Make sure pillows are completely dry. Foam rubber pillows take a long time to dry.</li> </ul> </li> <li>• Plastic – Shower curtains, tablecloths (20-30 minutes)</li> <li>• Rubber-backed rugs (40-50 minutes)</li> <li>• Olefin, Polypropylene, Sheer nylon (10-20 minutes)</li> </ul> <p><b>NOTE:</b> Always follow care label directions when they are available.</p>	<ul style="list-style-type: none"> <li>• This cycle is unheated and uses a 50-minute Timed setting that you can change.</li> <li>• Use the information in the box to the left to help select a time that will be appropriate for the items you are fluffing or drying.</li> </ul>
--	---	---

# OPERATING YOUR DRYER

## Using Automatic drying

In the Automatic cycles, the FLO-THRU™ Drying System automatically reduces the heat setting to prevent overdrying of fabrics. An electronic dryness sensor control senses the amount of moisture in the load and automatically shuts off the dryer when the selected dryness is reached.

(\*) Reg Dry is the preset dryness automatically selected for the Regular•Heavy/Hi, Perm Press/Med, Delicates/Low, and Fine Delicates/Ultra Low cycles. You can change the Automatic setting (or select a Timed setting) to match your load.

1. **Press On/Select until the light glows by the cycle you prefer (Regular•Heavy/Hi, Perm Press/Med, Delicates/Low, or Fine Delicates/Ultra Low).**

PRESS



YOU SEE

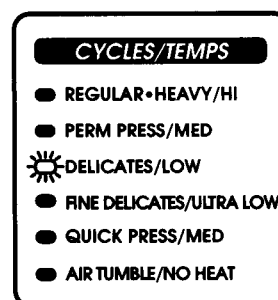

2. **Press Select until the light glows below "Automatic", and by the Automatic dryness you prefer. Make changes to any of the Options you wish to change (See pages 15-17).**

PRESS



YOU SEE

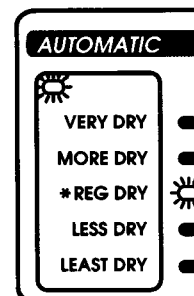

3. **Press Start.** The "Drying" Status light will glow.

PRESS



### NOTES:

- If the load is drier than you would like, select Less Dry or Least Dry the next time you dry a similar load.
- If the load is not as dry as you would like, complete drying using a Timed setting. Select More Dry or Very Dry the next time you dry a similar load.
- When you press Select, the Automatic dryness settings are selected first (starting with (\*) Reg Dry). Continue to press Select for a Timed setting (see page 14).

# OPERATING YOUR DRYER

## Using Timed drying

Use Timed drying to complete drying if some items are damp after using an Automatic cycle, or to dry delicate items that require a short drying time.

1. **Press On/Select** until the light glows by the cycle you prefer.

PRESS



YOU SEE

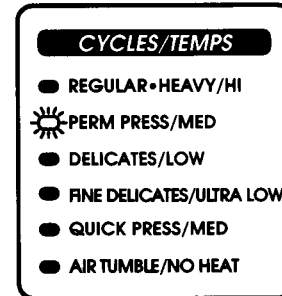

2. **Press Select** until the light glows below "Timed" and by the drying time you prefer. Make changes to any of the Options you wish to change (See pages 15-17).

PRESS



YOU SEE

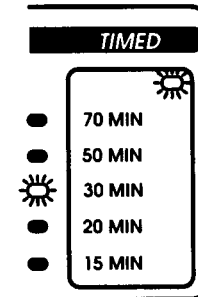

**NOTES:**

- If you select the Regular•Heavy/Hi, Perm Press/Med, Delicates/Low, or Fine Delicates/Ultra Low cycle, an Automatic dryness is preset.
- If you prefer to have a Timed dry instead, continue to press Select until the Timed light glows (Automatic light shuts off) and the light glows by the time you prefer. If you pass the desired time, repeat Step 2.

3. **Press Start.** The "Drying" Status light will glow.

PRESS



# USING OTHER FEATURES

Your electronic dryer has several features that help you customize your drying cycles. The information in this section helps you understand how and when to use your dryer's special features.

## Using the Cycle Signal and Extra Care options

Your electronic dryer automatically selects the Cycle Signal and Extra Care options when you press On/Select. You can turn one or both options Off if you prefer. Each time you press Select/Lock Out, you turn an option On or Off.

- Press Select/Lock Out under the Options section of your control panel **once** to turn both options Off.

**PRESS**



**YOU SEE**

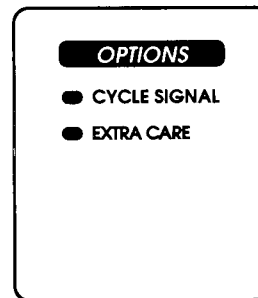

- Press Select/Lock Out **twice** to turn only the Cycle Signal On.

**PRESS**



**YOU SEE**

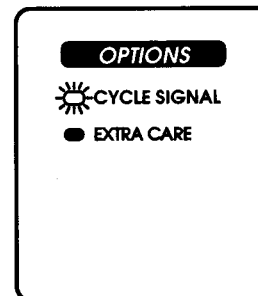

- Press Select/Lock Out **three times** to turn only Extra Care On.

**PRESS**



**YOU SEE**

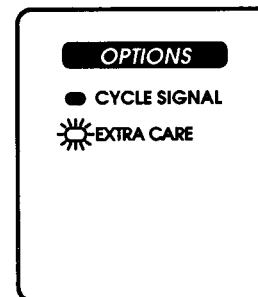

continued on next page

# USING OTHER FEATURES

## Using the Cycle Signal and Extra Care options (cont.)

- Press Select/Lock Out **four times** to turn both options On again.

PRESS



YOU SEE

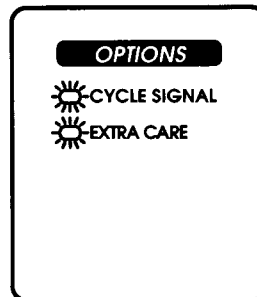

## Understanding the End of Cycle signal

Your dryer sounds an End of Cycle signal to let you know when the selected cycle is finished. The signal is helpful when drying permanent press, synthetics, and other items that should be removed from the dryer as soon as it stops.



The signal can be turned On or Off, as described above.

## Understanding the Extra Care option

The Extra Care feature protects your clothing from wrinkles if you are unable to unload the dryer within 5 minutes after tumbling stops. The load is tumbled without heat every few minutes up to 150 minutes. A signal sounds every few minutes when Extra Care is running. The signal and cycle stop when you open the door or press Cancel.

YOU SEE

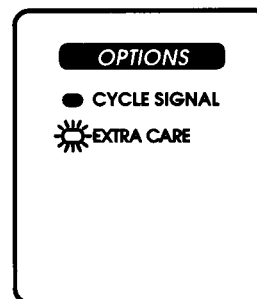



# USING OTHER FEATURES

## Understanding the Custom Memory feature

The Custom Memory feature lets you tailor your cycle settings to match your drying needs. When you press Start, all options that have been selected within the cycle you choose are saved. These customized options will be displayed each time the cycle is selected.

- For any of the Automatic cycles (see “Using Automatic drying” on page 13), you can change the dryness level or Timed setting, End of Cycle signal, and Extra Care options.

- For the Quick Press/Med cycle, you can change the End of Cycle signal and Extra Care options.
- For the Air Tumble/No Heat cycle, you can change the Timed setting, End of Cycle signal, and Extra Care options.

## Using the Lock Out feature

The Lock Out feature allows you to “lock out” others from using your dryer, which is especially useful if you have young children. Once Lock Out is activated, the control panel is disabled from use.

**NOTE:** You can only select Lock Out when your dryer is not in use.

### To select Lock Out:

1. **Press Cancel** to turn the control panel off.
2. **Press and hold Select/Lock Out for 5 seconds.** When you release the key, the light next to Lock Out (under the Status section of the control panel) will glow.

**PRESS**



**YOU SEE**

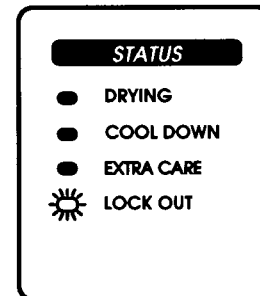

### To unlock the control panel:

- **Press and hold Select/Lock Out for 5 seconds.** When you release the key, the light next to Lock Out will turn off, and your dryer will be ready to use.

## Status lights

Status lights glow when your dryer is operating, indicating the various stages of the drying cycle.

If the status lights are blinking, there has been a power failure. Press Cancel, then make your new selections.

**YOU SEE**

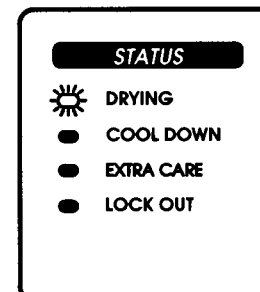

# USING OTHER FEATURES

## Using the drying rack

The drying rack lets you dry items without tumbling them. The rack does not move, but the drum turns.

1. Fit rear legs of the rack into spaces in the back wall of the dryer. Lower the front so the legs rest on the dryer opening.

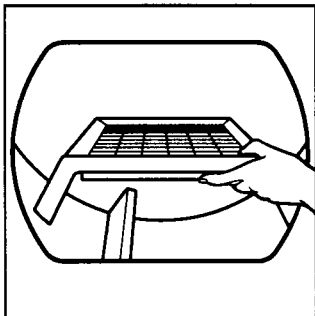

Lower the front so the legs rest on the dryer opening.

2. Put wet items on top of the rack. Leave space between the items so air can reach all surfaces.

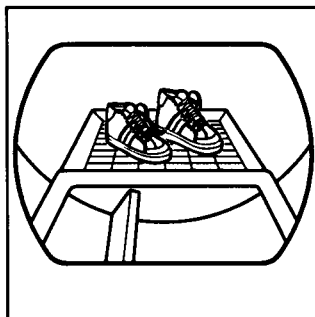

- See chart below for suggested cycles and settings for items that might best be rack dried. Drying time will depend on amount of moisture items hold.

**NOTE:** Make sure nothing hangs over the edge of the rack.

3. Close the door.

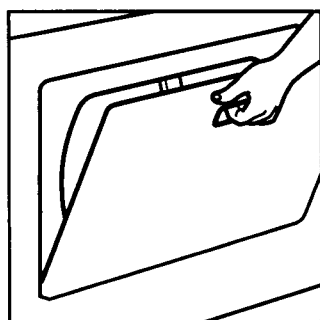

4. Select a Timed drying cycle (see page 14), or the Air Tumble cycle.

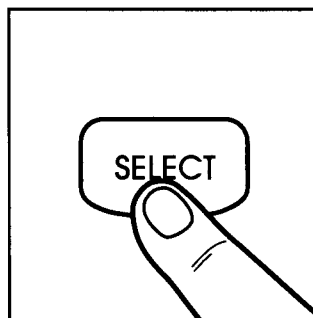

5. Press the Start Button.

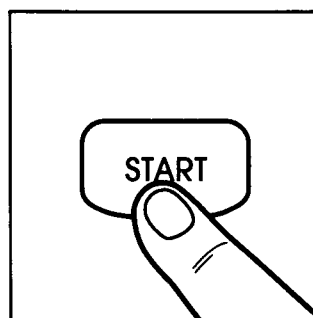

**NOTE:** The rack must be removed for normal tumbling. Automatic cycles do not work with the drying rack.

RACK DRY	CYCLE	TEMPERATURE	TIME* (minutes)
<b>Wool sweaters</b> (Block to shape and lay flat on the rack)	Timed	Low	50
<b>Stuffed toys or pillows</b> (Cotton or polyester fiber filled)	Timed	Low	50
<b>Stuffed toys or pillows</b> (Foam rubber filled)	Air Tumble	None; cycle is unheated.	70
<b>Sneakers or canvas shoes</b>	Air Tumble	None; cycle is unheated.	30-50

\* Reset cycle as needed to complete drying.

# CARING FOR YOUR DRYER

Proper care of your dryer can extend its life and help your dryer operate efficiently.

## Cleaning the lint screen

### Every load cleaning

The lint screen is located under a lid on top of the dryer. **Clean it before each load.** A screen blocked by lint can increase drying time.

#### To clean:

1. Open the lid and pull the lint screen towards you.

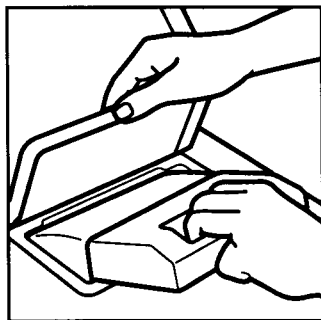

2. Roll lint off the screen with your fingers. Do not rinse or wash screen to remove lint. Wet lint is hard to remove.

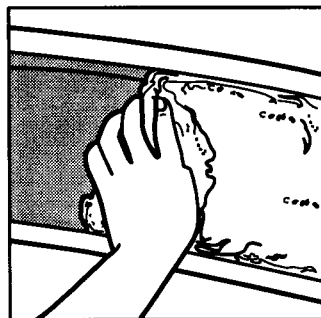

3. Push the lint screen firmly back into place and close the lid.

#### IMPORTANT:

- Do not run the dryer with the lint screen loose, damaged, blocked, or missing. Doing so can cause overheating and damage to both the dryer and fabrics.
- Some towels made of synthetic fibers and natural fibers (polyester and cotton blends) may shed more lint than other towels, causing your dryer's lint screen to fill up faster. Be sure to remove lint from the lint screen before and after drying new towels.

### As needed cleaning

Laundry detergents and fabric softeners can cause a residue buildup on the lint screen. This buildup can cause longer drying times for your clothes, or cause the dryer to stop before your load is completely dry. You may be able to see this buildup, or the lint may be falling off the screen because it is clogged.

Clean the lint screen with a nylon brush every six months or more frequently if it becomes clogged due to a residue buildup.

#### Use the following method:

1. Wet both sides of lint screen with hot water.
2. Wet a nylon brush with hot water and liquid detergent; scrub lint screen with the brush to remove residue buildup.

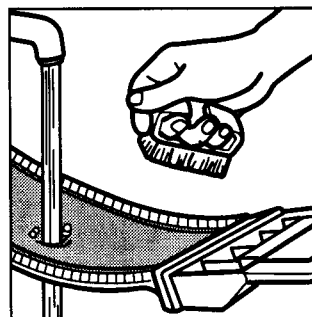

detergent; scrub lint screen with the brush to remove residue buildup.

3. Rinse screen with hot water.
4. **Thoroughly** dry lint screen with a clean towel; replace in dryer.

# CARING FOR YOUR DRYER

## Lint signal



The lint signal (a whistle tone) indicates excessive lint is present on your lint screen, or it has a residue buildup. See page 19. A full lint screen restricts airflow and reduces drying efficiency. When you hear the signal, stop the dryer and clean the lint screen.

**NOTE:** Clean your lint screen before each load. Do not wait for the lint signal.

## Cleaning the dryer interior

Garments which contain unstable dyes, such as denim blue jeans or brightly colored cotton items, may discolor the dryer interior. These stains are **not** harmful to your dryer and will not stain future loads of clothes. It is helpful to dry unstable dye items inside out to prevent dye transfer.

### To clean dryer drum:

1. Make a paste with powdered laundry detergent and very warm water.
2. Apply paste to a soft cloth.

### OR

Apply a liquid, non-flammable household cleaner to the stained area and rub with a soft cloth until all excess dye is removed.



3. Wipe drum thoroughly with a damp cloth.
4. Tumble a load of clean cloths or towels to dry drum.

## **⚠ WARNING**



### **Explosion Hazard**

**Use nonflammable cleaner.**

**Failure to do so can result in death, explosion, or fire.**

# CARING FOR YOUR DRYER

## Changing the drum light

The dryer light automatically turns on inside the dryer drum when you open the door. Your dryer's drum light may be one of two types, as shown.

### ⚠ WARNING



#### Fire Hazard

Replace light bulb cover before operating dryer.

Failure to do so can result in death or fire.

### To change drum light type 1:

1. Unplug the dryer or disconnect the electricity leading to the dryer at the main power supply.
2. Open the dryer door. Remove the light bulb cover from the back wall of the dryer by turning the cover clockwise.

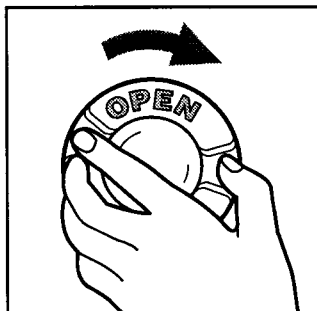

from the back wall of the dryer by turning the cover clockwise.

3. Remove the light bulb by turning it counterclockwise.
4. Replace the bulb with a 40-watt appliance bulb only.
5. Replace the light bulb cover and lock in place by turning counterclockwise.

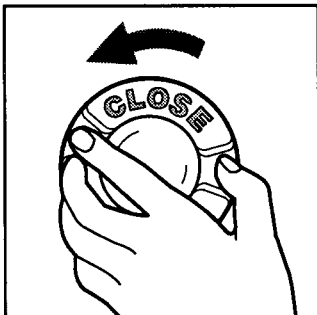

6. Reconnect power supply.

### To change drum light type 2:

1. Unplug the dryer or disconnect the electricity leading to the dryer at the main power supply.
2. Open the dryer door. Remove the light bulb cover from the back wall of the dryer by removing the screw located in the lower right corner of the cover.

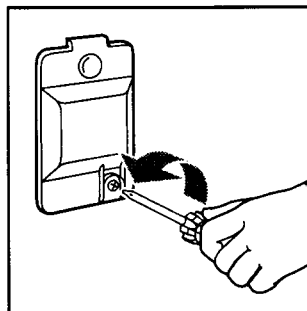

from the back wall of the dryer by removing the screw located in the lower right corner of the cover.

3. Remove the light bulb by turning it counterclockwise.
4. Replace the bulb with a 10-watt appliance bulb only.
5. Replace the light bulb cover.

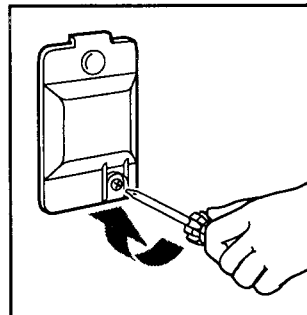

6. Reconnect power supply.

# CARING FOR YOUR DRYER

## Removing accumulated lint from inside the dryer cabinet

Lint can gather inside the dryer and be a fuel for fire. Lint should be removed every two to three years, or more often, depending on dryer usage. Cleaning should be done by a qualified person. If you have any questions or comments, please call our Consumer Assistance Center at **1-800-422-1230** from anywhere in the U.S.A.

### **⚠ WARNING**



**Electrical Shock Hazard**  
**Disconnect power before cleaning.**  
**Replace all panels before operating.**  
**Failure to do so can result in death or electrical shock.**

1. Unplug dryer or turn off power supply.
2. Remove rear panel.
3. Remove any lint using a vacuum cleaner or soft brush. Avoid damaging wires and thermostats.
4. Replace rear panel.

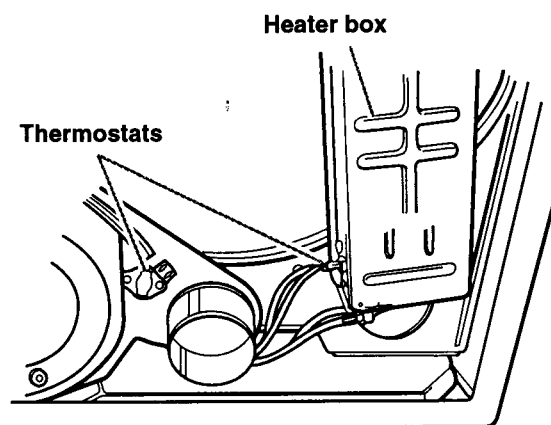

**Dryer with rear panel removed**

5. Open lint screen lid. Remove 2 screws from lint screen area.
6. Open top by pulling forward and up at each front corner (see illustration). Rest raised top against wall behind dryer (top is hinged at rear).

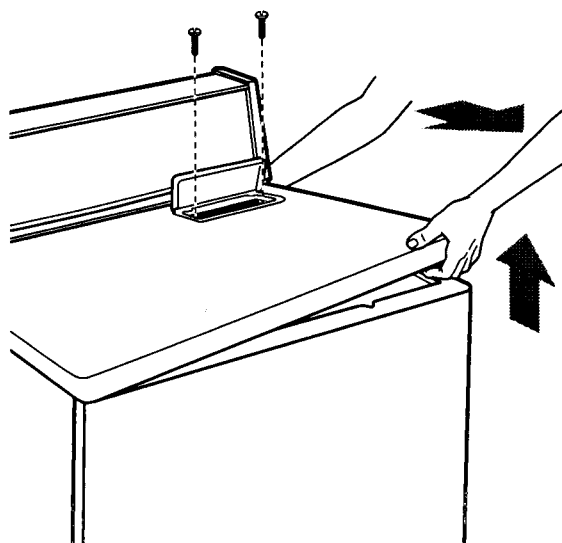

# CARING FOR YOUR DRYER

## Removing accumulated lint from inside the dryer cabinet (cont.)

7. Remove 2 internal screws from front panel flanges (near top front corners). Lift front panel slightly, lifting off lower clips (see lower clip inset of illustration below). Slowly pull front panel forward, disengaging panel from drum. (Drum will drop slightly.)
8. Move front panel aside and rest edge against side of dryer. Avoid disconnecting wire clips (see wire clips inset of illustration below) or damaging wires.
9. Remove any lint using a vacuum cleaner or soft brush.

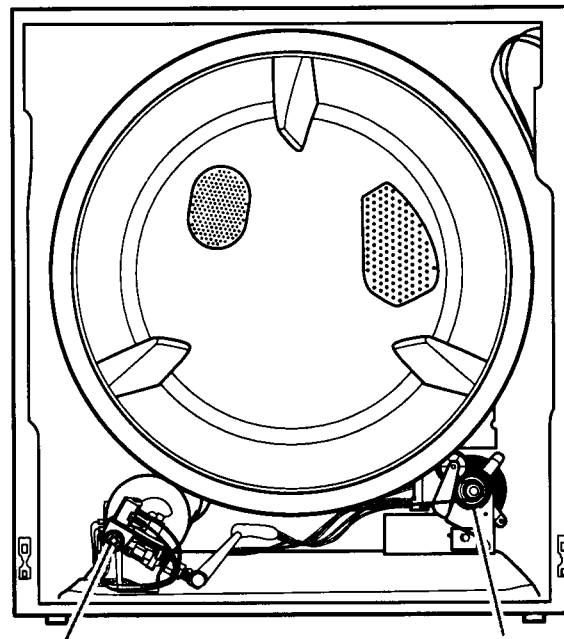

Burner  
(gas models only)

Motor

Dryer with front panel removed

10. Reassemble in reverse order. Before closing the top, check the following:
  - Drum seal must be flared out (see drum seal insets of illustration) and properly positioned against panel at back of drum. Rotate drum counterclockwise one full turn to check drum seal.
  - Belt should be centered and tight on dryer drum.
  - Wire clip retainer, which holds the door switch wires, must be secured to top of front panel (see wire clips inset of illustration) and along top edge of side panel. Door wires must not touch drum when dryer is operating.
11. Replace top panel and lint screen screws. Top and front panels must be securely in place before operating dryer.
12. Level the dryer if necessary.
13. Plug in dryer or turn on power supply.

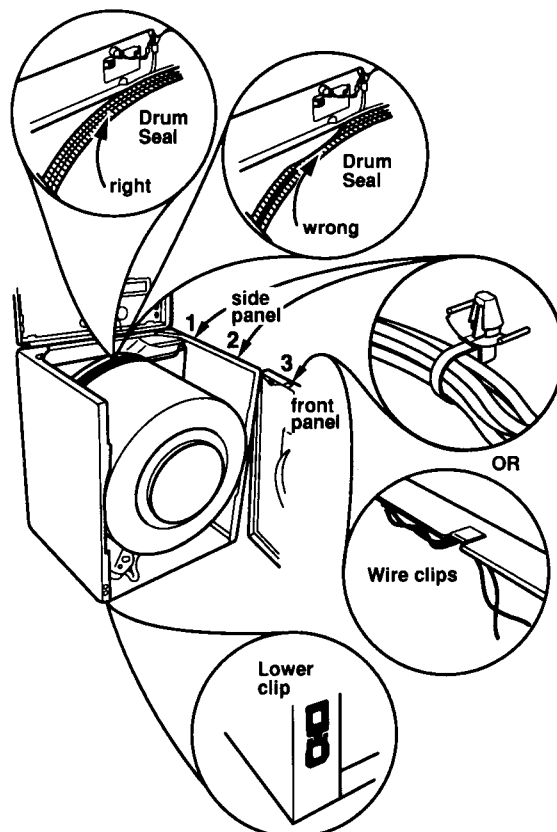

# TROUBLESHOOTING

Most laundering problems are easily solved if you understand the cause. Check the following list for **common laundry problems** and the next page for **common dryer problems**. If you need further assistance, see "Requesting Assistance or Service" on page 26.

**NOTE:** In the following list, the most common laundry problems are listed first.

## Common laundry problems

Problem ...	Cause ...
Slow drying or clothes still wet	<ul style="list-style-type: none"><li>• Incorrect cycle or temperature setting selected.</li><li>• Full or clogged lint screen. (See page 19.)</li><li>• Exhaust vent clogged, restricted, or too long. (See pages 6-7 and Installation Instructions.)</li><li>• Dryer not level to allow for clothes contacting the electronic dryness sensor.</li><li>• Dryer located in room with temperature below 45° (7°C).</li><li>• Load too large and bulky to dry quickly.</li><li>• Drying heavy fabrics (denim, towels) with light fabrics (synthetics, permanent press).</li><li>• Fabric softener sheet blocking exhaust grill inside dryer drum.</li></ul>
Lint	<ul style="list-style-type: none"><li>• Full lint screen. (See page 19.)</li><li>• Load not properly sorted.</li><li>• Overdrying, especially synthetic fabrics that cause lint-attracting static electricity.</li><li>• Load size too big or heavy.</li><li>• Tissue or paper left in pockets.</li><li>• Pilling (surface fuzz caused by normal wear and laundering) attracts lint.</li></ul>
Static electricity	<ul style="list-style-type: none"><li>• Overdrying.</li><li>• Dryer fabric softener improperly used. See package directions.</li><li>• Load includes synthetics, synthetic blends, permanent press, and knit fabrics that build up static electricity.</li></ul>
Wrinkling	<ul style="list-style-type: none"><li>• Overloading.</li><li>• Overdrying, especially permanent press and synthetic fabrics.</li><li>• Large items balling or rolling up.</li><li>• Clothes left in dryer at end of cycle.</li></ul>
Shrinking	<ul style="list-style-type: none"><li>• Overdrying.</li><li>• Fabric or garment is not designed for tumble drying.</li><li>• Dryer settings incorrect for fabric type.</li><li>• Care label instructions not followed.</li></ul>
Greasy spots/stains	<ul style="list-style-type: none"><li>• Dryer fabric softener improperly used. Do not add to a warm load.</li><li>• Drying soiled items.</li></ul>
Color change	<ul style="list-style-type: none"><li>• Drying dark colors with light colors.</li><li>• Drying colorfast colors with non-colorfast colors.</li></ul>
Garment damage	<ul style="list-style-type: none"><li>• Zippers, snaps, and hooks left open.</li><li>• Strings and sashes not tied to prevent tangling.</li><li>• Care label instructions not followed.</li></ul>



# TROUBLESHOOTING

## Common dryer problems

### 1. Dryer will not start.

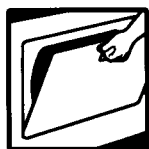

Is the dryer door firmly closed?



Have you selected a cycle?



Did you firmly press the Start Button?



Is the power cord plugged in?

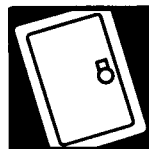

Have you blown a fuse or tripped the circuit breaker? Electric dryers use 2 household fuses or breakers.

### 2. Lint accumulation in hood or exhaust vent, or extended drying times.



Is the lint screen full?



Is exhaust vent or outside exhaust hood clogged with lint? Refer to venting section on pages 6-7.

### 3. No heat



For gas dryers, is the valve open on the supply line? Also, some dryers may have an internal gas valve.

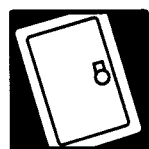

For electric dryers, have you blown a fuse or tripped a circuit breaker? Electric dryers use 2 household fuses or breakers. The drum may be turning but you may not have heat.

### 4. Noises



Does lint screen need to be cleaned (lint alert)?  
If the dryer hasn't been used for awhile, there may be a thumping sound during the first few minutes of operation.

If noises continue, call the Consumer Assistance Center.

### 5. Odor



When operating a new dryer, the new electric heating element may have an odor.

Are household chemical odors being drawn into dryer? Proper ventilation needs to be used if painting or staining near the dryer.

**NOTE:** Store and use paints, varnishes, etc. away from your dryer whenever possible.

If you still have problems, see "Requesting Assistance or Service" on page 26.

# REQUESTING ASSISTANCE OR SERVICE

Before calling for assistance or service, please check "Troubleshooting" on pages 24 and 25. It may save you the cost of a service call. If you still need help, follow these instructions.

## If you need assistance or service

### Call the KitchenAid Consumer Assistance



**Center toll free:  
1-800-422-1230.**

**When calling:**

Please know the purchase date, and the complete model and serial number of your appliance (see page 2). This information will help us to better respond to your request.

#### **We will provide you with:**

- Use and maintenance procedures.
- Installation information.
- Features and specifications on our full line of appliances.

- Accessory and repair parts sales.
- Do-it-yourself repair help.
- Specialized customer assistance (Spanish speaking, hearing impaired, limited vision, etc.).
- Referrals to local dealers, service companies, and repair parts distributors.

**KitchenAid service technicians** are trained to fulfill the product warranty and provide after-warranty service, anywhere in the United States.

To locate the authorized KitchenAid service company in your area, you can also look in your telephone directory Yellow Pages.

## If you need replacement parts ...

If you need to order replacement parts, we recommend that you only use factory authorized parts. These parts will fit right and work right, because they are made with the same precision used to

build every new KITCHENAID® appliance. To locate factory authorized replacement parts in your area, call our Consumer Assistance Center telephone number or your nearest authorized service center.

## For further assistance ...

If you need further assistance, you can write to KitchenAid with any questions or concerns at:

KitchenAid Brand Home Appliances  
Consumer Assistance Center  
c/o Correspondence Dept.  
2000 North M-63  
Benton Harbor, MI 49022-2692

Please include a daytime phone number in your correspondence.

If the dealer, authorized servicer, and KitchenAid have failed to resolve your problem, you can contact the Major Appliance Consumer Action Program (MACAP). MACAP is a group of independent consumer experts that voices consumer views at the highest levels of the major appliance industry. MACAP will in turn inform us of your action.

Major Appliance Consumer Action Program  
20 North Wacker Drive  
Chicago, IL 60606

# INDEX

This index is alphabetical. Look for the word or phrase you are interested in, then look for the page number.

<u>TOPIC</u>	<u>PAGE</u>	<u>TOPIC</u>	<u>PAGE</u>
AIR TUMBLE/NO HEAT .....	12	END OF CYCLE SIGNAL .....	16
ASSISTANCE .....	26	LINT	
AUTOMATIC CYCLES		Removal .....	19, 22
Delicates/Low .....	11	Screen .....	19
Fine Delicates/Ultra Low .....	11	Signal .....	20
Perm. Press/Med .....	11	LOCK OUT .....	17
Regular•Heavy/Hi .....	10	SAFETY .....	3-4
Using .....	13	SELECTING CYCLE/SETTING .....	10-12
CARE/CLEANING		SELECTRA™ ELECTRONIC CONTROLS .....	8
Dryer interior .....	20	SERVICE .....	26
Lint screen .....	19	TIMED CYCLES	
CUSTOM MEMORY .....	17	Air Tumble/No Heat .....	12
CYCLES .....	10-12	Quick Press/Med .....	12
DRUM LIGHT .....	21	Using .....	14
DRYER		TROUBLESHOOTING	
Before starting .....	8	Dryer problems .....	25
Features .....	5	Laundry problems .....	24
Restarting .....	9	WARRANTY .....	28
Safety .....	3-4		
Starting .....	9		
Stopping .....	9		
DRYING			
Cycles .....	10-12		
Rack .....	18		

# DRYER WARRANTY

LENGTH OF WARRANTY:	KITCHENAID WILL PAY FOR:	KITCHENAID WILL NOT PAY FOR:
<b>TWO YEAR FULL WARRANTY</b> FROM DATE OF PURCHASE	Replacement parts and repair labor costs to correct defects in materials or workmanship. Service must be provided by an authorized KitchenAid servicing outlet.	<b>A.</b> Service calls to: <ol style="list-style-type: none"> <li>1. Correct the installation of the dryer, including venting. Heavy four-inch metal exhaust vent <b>must</b> be used. Refer to the venting section of this manual and your Installation Instructions.</li> <li>2. Instruct you how to use the dryer.</li> <li>3. Replace house fuses or correct house wiring.</li> <li>4. Correct house plumbing.</li> </ol> <b>B.</b> Repairs when dryer is used in other than normal home use. <b>C.</b> Damage resulting from accident, alteration, misuse, abuse, improper installation (including, but not limited to, venting with plastic or flexible foil), or installation not in accordance with local electrical or plumbing codes. <b>D.</b> Any labor costs during limited warranties. <b>E.</b> Replacement parts or repair labor costs for units operated outside the United States. <b>F.</b> Pickup and delivery. This product is designed to be repaired in the home. <b>G.</b> Repairs to parts or systems caused by unauthorized modifications made to the appliance.
<b>THIRD THROUGH FIFTH YEAR LIMITED WARRANTY</b> FROM DATE OF PURCHASE	Replacement parts for any electrical element on electric models or any burner on gas models to correct defects in materials or workmanship. Replacement of the motor due to defects in materials and workmanship. Replacement parts for SELECTRA™ electronic controls if defective in materials or workmanship.	
<b>THIRD THROUGH TENTH YEAR LIMITED WARRANTY</b> FROM DATE OF PURCHASE	Replacement parts for the dryer drum if it rusts due to defects in materials or workmanship. Replacement parts for the dryer top/cabinet assembly should any sign of rust appear due to defects in materials or workmanship.	

6/96

**KITCHENAID DOES NOT ASSUME ANY RESPONSIBILITY FOR INCIDENTAL OR CONSEQUENTIAL DAMAGES.** Some states do not allow the exclusion or limitation of incidental or consequential damages, so this exclusion or limitation may not apply to you. This warranty gives you specific legal rights and you may also have other rights which may vary from state to state.

**Outside the United States, a different warranty may apply. For details, please contact your authorized KitchenAid dealer.**

If you need assistance or service, first see the "Troubleshooting" section of this book. After checking "Troubleshooting," additional help can be found by checking the "Requesting Assistance or Service" section. In the U.S.A., call our Consumer Assistance Center at **1-800-422-1230**.

KitchenAid  
Benton Harbor, MI 49022-2692 U.S.A.

**PART NO. 3405631 Rev. B**  
**CARD NO. 2195265**